

KOBELCO

SK230SRLC

■ Bucket Capacity:

0.51 - 0.93 m³

■ Engine Power:

124 kW / 2,000 min⁻¹

■ Operating Weight:

23,800 - 24,300 kg



Complies with the EU Stage V
exhaust emission regulation

We Save You Fuel
Achieving a Low-Carbon Society

Power Meets Efficiency

With iNDr for even quieter operation.

SK230SR_{LC}





“KOBELCO has made the short rear swing excavator the standard for mid-sized machines. And with ongoing development in innovations such as the iNDR noise reduction system that both shuts out dust and cuts noise, KOBELCO is boosting value and leading the industry with construction machinery ideally suited to the urban environment.

The new SK230SRLC retains the compact shape and iNDR system advantages that KOBELCO has pioneered, but it has been fitted with a new and larger engine assembly for improved environmental protection. Low fuel consumption is balanced against increased work performance, and machine durability has been advanced.

The new worldwide-model SK230SRLC. Working for the planet.”



Low Noise and Easy Maintenance Mean Greater Value Than Ever. A New Design Approach Leads to a Revolutionary Double Offset Duct Structure.

By reviewing the iNDr configuration, Kobelco achieved both great visibility and a compelling design even though the engine compartment has been enlarged to meet Stage V standards, maintaining the value of iNDr.

iNDr absorbs sound energy to minimize noise by making a path of air, which cools down engine, as one engine cooling ducts. The new model is equipped with a selective catalytic reduction (SCR) unit, which required a new design with two offset ducts on top. This allows ample space to absorb engine noise, making these new excavators as quiet as conventional models.



The Results Are Exceptional. The Big Merits:

“Ultimate Low Noise” is achieved by minimizing sound leakage during operation

Noise from the engine and cooling fan is absorbed by the duct, so the machine far surpasses legal requirements. Kobelco calls this system, which exceeds all noise standards, “Ultimate Low Noise,” and it reduces noise to 97dB(A).

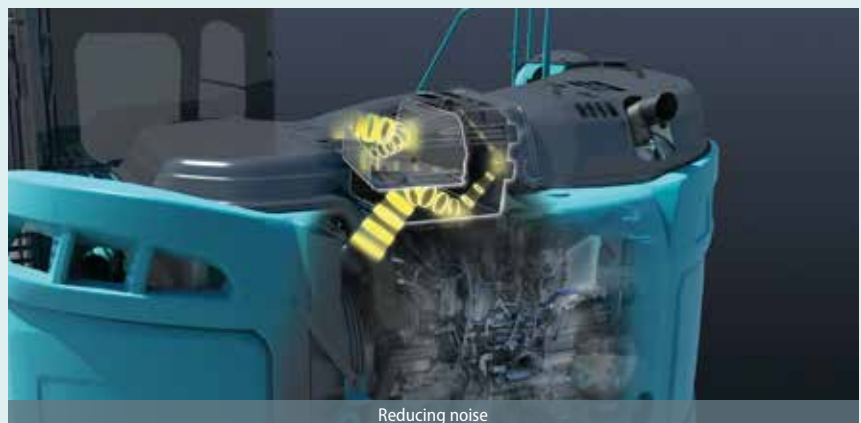

Reducing noise

Eliminating dust maintains cooling system performance

The high-density 60-mesh filter* blocks out dust in the intake air. This prevents clogging of the cooling system and the air cleaner, which maintains peak performance. The waveform filter allows air through the tops of the waves while collecting dust at the bottom, ensuring a smooth airflow.



How the filter catches dust

*“60-mesh” means that there are 60 holes formed by horizontal and vertical wires in every square inch of filter.



Blocking out dust

Easy filter maintenance system simplifies cleaning

Daily inspection consists of a visual check of the iNDr filter only. If it looks dirty, it can be removed and washed without special tools.





Wide, clear view to the rear

Even with the larger engine compartment, the design minimizes hood height, ensuring an excellent direct view to the rear. In addition, the operator can monitor conditions behind the machine with clear, wide-angle images from the rear-view camera, which comes as standard equipment.



NOx emissions cut

New, Environmentally Friendly Engine

SCR System with DEF/Urea NEW

The engine exhaust system has an SCR system that converts NOx emissions into harmless nitrogen and water. Combining this with a post-exhaust gas treatment system that captures and disposes of PM, the SK230SRLC has a much cleaner exhaust that meets Stage V exhaust emission standards.



■ NOx reduction rate
(Compared to previous models)

About **88%** decrease

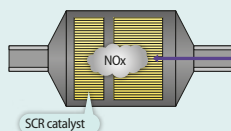

Reduces fuel consumption and minimizes exhaust emissions

Hino engines are renowned for fuel efficiency and environmental performance, and KOBELCO has tuned them specifically for construction machinery. The high-pressure common rail fuel injection system, the variable-geometry (VG) turbocharger, and the exhaust gas recirculation (EGR) system reduce particulate matter (PM) while the large EGR cooler greatly reduces the formation of Nitrogen Oxide (NOx) gases.

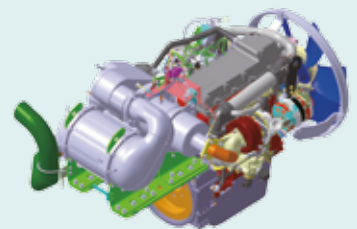

At high temperatures, nitrogen and oxygen combine to produce nitrous oxides (NOx). Reducing the amount of oxygen and lowering the combustion temperature results in much less NOx.

EGR cooler

While ensuring sufficient oxygen for combustion, cooled emission gases are mixed with the intake air and recirculated into the engine. This reduces oxygen content and lowers combustion temperature.

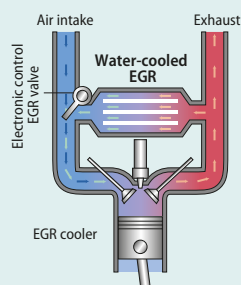

PM emissions cut

Particulate matter (PM) is mostly soot resulting from incomplete combustion; Improved combustion efficiency reduces PM emissions. Filter further reduces PM emissions.

Common rail system

High-pressure injection atomizes the fuel, and more precise injection improves combustion efficiency. This also contributes to better fuel economy.

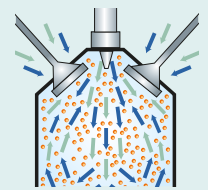

Common rail system

Unbeatable Cost Performance

Greater Work Capacity:
Exceeding Expectations in Productivity

Improved Fuel Efficiency Contributes to High Performance

Superior Digging Volume

This excavator offers dynamic digging force even as it minimizes fuel consumption rates, achieving class-leading work volume.

■ Max. bucket digging force (Power Boost engaged)

132 kN (ISO 6015)

■ Max. arm crowding force (Power Boost engaged)

96.8 kN (ISO 6015)



Energy-efficient System

ECO-mode: engineered for economy

Kobelco's ECO-mode maximizes the operating efficiency of the engine and other components to achieve much greater fuel efficiency. Just press a button to choose the operation mode best suited to the task at hand and the working conditions.

■ Optimal operation with three modes

- H** H-mode ••• Maximum power for maximum productivity on your toughest jobs
- S** S-mode ••• Ideal balance of productivity and fuel efficiency for a range of urban engineering projects
- E** ECO-mode ••• Minimum fuel consumption for utility projects and other work that demands precision

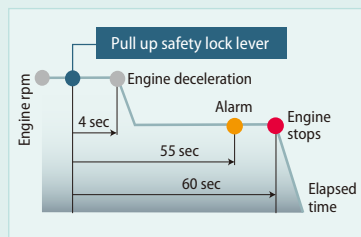

AIS (Auto Idle Stop)

If the boarding/disembarking lever is left up, the engine will stop automatically. This eliminates wasteful idling during standby, saving fuel and reducing CO₂ emissions as well.

Hydraulic system engineered to reduce energy loss

Kobelco's proprietary hydraulic systems offer hydraulic line positioning that reduces friction resistance and valves designed for higher efficiency, minimizing energy loss throughout the system.

**Always and forever.
Yesterday, today, and tomorrow.
We're obsessed with fuel efficiency**

Over the past 8 years, KOBELCO has achieved an average fuel consumption reduction of 31% across its fleet. We vow to lead the industry in improving fuel efficiency.

■ Compared to SK200SR-IS (2004)

E ECO-mode (SK230SRLC-5) ••• About **31%** improvement

Ideal for Urban Work Sites Provides a Broad Working Range, Even in Close Quarters

Minimal swing radius improves efficiency

The tail of the upper body extends very little past the crawlers, so the operator can concentrate on the job at hand. This also reduces the risk of collision damage.

Easy workability in less than 4,060mm of space

The compact design allows continuous 180° dig, swing, and load operations within a working space of just 4.06m.

Seamless feeling, smooth combined operations

The machines have inherited the various systems that make inching and combined operations easy and accurate. Leveling and other combined operations can be carried out with graceful ease.

Swing operation cuts cycle times

Fast cycle times as a result of fast swing and boom operations.

Strong drawbar pulling force produces powerful travel capabilities

These new excavators handle steep slopes and rough roads with ease while ensuring smooth changes in direction.

Drawbar pulling force: 229 kN

Excellent working ranges

Greater working ranges with class-topping vertical digging depth.

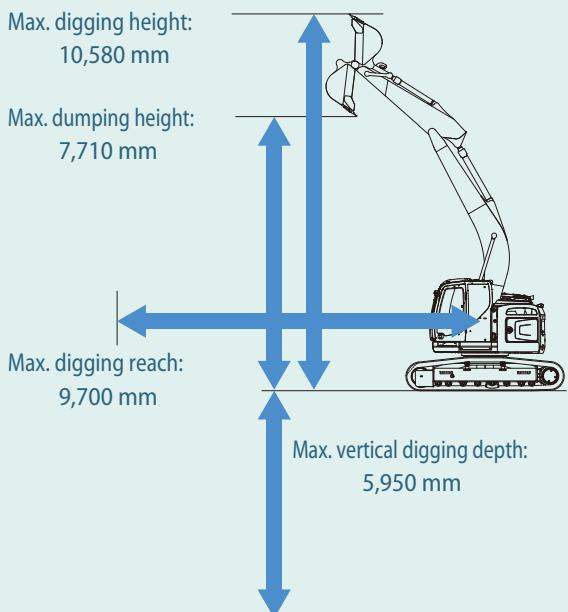

Easy hydraulic piping for quick hitch

A quick hitch hydraulic line, which speeds up attachment changes, is available as standard.



Comprehensive Safety and Intuitive Operation

User-friendly design and enhanced safety means greater efficiency and productivity.



Operator-friendly Features Include Controls that Are Easy to See, Easy to Use



Multi-display in color

Brilliant colors and graphic displays are easy to recognize on the LCD multi-display in the console. The display shows fuel consumption, maintenance intervals, and more.

- 1 Analog gauge provides an intuitive reading of fuel level and engine water temperature
- 2 Green indicator light shows low fuel consumption during operation
- 3 PM accumulation display (left)/Urea level gauge (right)
- 4 Fuel consumption
- 5 Digging mode switch
- 6 Monitor display switch

One-touch attachment mode switch

A simple flick of a switch converts the hydraulic circuit and flow amount to match attachment changes. Icons help the operator to confirm the proper configuration at a glance.

Safety

ROPS cab

ROPS (Roll-Over-Protective Structure)-compliant cab clears ISO standards (ISO-12117-2: 2008) and ensures greater safety for the operator should the machine tip over.



Top Guard level II
(Meets ISO10262)



Mounting brackets for vandalism guards are standard equipment (contact your KOBELCO dealer to fit vandalism or front rock guards).

Expanded field of view for greater safety



Left rear view mirror



Rear view from cab

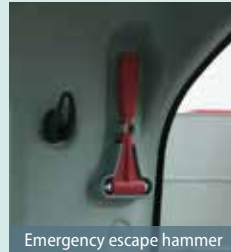

Emergency escape hammer

Right side camera fitted as standard NEW

Further to the existing rear-view camera, a camera for the right side is fitted as standard for easy safety checks all round the machine.



Rear-view camera



Right-side camera

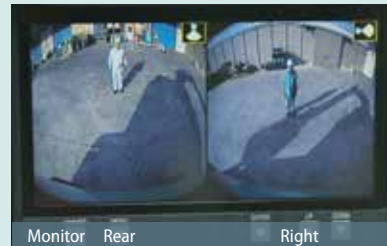

Monitor Rear Right



Urea accumulation display



Fuel consumption

	INTERVAL	REMAINING TIME	EXCHANGE DAY
ENGINE OIL	500	494	—/—/—
FUEL FILTER	500	494	—/—/—
HYD. FILTER	1000	994	—/—/—
HYD. OIL	5000	4994	—/—/—

Maintenance

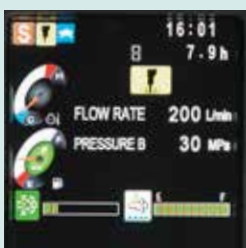

Breaker mode

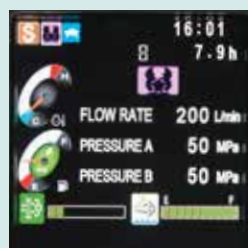

Nibbler mode

Cab Design That Puts the Operator First

Wide and open, the cab's interior overflows with features that streamline operation



Comfort

Big roomy cab

The cube design makes the most of straight lines, so the cab interior is 4% more spacious than before. Operating space literally spreads out before the operator. And the 50Pa airtightness keeps dust outside.

A Light Touch on the Lever Means Smoother, Less Tiring Work

It takes 25% less effort to work the operation lever, which reduces fatigue over long working hours or continued operations.



Wide-open field of view

On the right side, the large single window has no center pillar, and the whole cab is designed for a wide field of view, giving the operator a direct view ahead and to the left and right. Mirror makes it easy for the operator to make sure things are safe all around.



Wide doors and ample head clearance mean smooth entry and exit

The control box and safety lock lever tilt up at a larger angle, and the door handle height is positioned for easy cab entry and exit.



More comfortable seat means higher productivity

The cab interior offers a host of operator comforts. The seat guarantees comfort whether on the job or at rest, and everything is ergonomically planned and laid out for smooth, stress-free operation.



Seat suspension absorbs vibration



Seat recliner can be greatly tilted



Double slides allow adjustment for optimum comfort

Equipment designed for comfort and convenience



Bluetooth installed radio **NEW**

Bluetooth installed to allow connections with smartphones and other devices.



Powerful automatic air conditioner

Also standard is an automatic air conditioner that maintains a comfortable interior environment all year around.



Spacious storage tray



Large cup holder



USB/AUX



12V power outlet

Proper Maintenance Ensures Peak Efficiency

Kobelco machines are designed for quick, simple inspection and maintenance.



Machine Information Display Function

- Displays only the maintenance information that's needed, when it's needed
- Self-diagnostic function provides early-warning detection and display of electrical system malfunctions
- Service-diagnostic function makes it easier to check the status of the machine
- Record function of previous breakdowns including irregular and transient malfunction

Maintenance information display

Easy, on-the-spot maintenance NEW



Urea tank
Urea filler cap is placed on the step for easy access.



Engine maintenance
Setting up maintenance area one step down allows easy to access to the engine.



Handrail
The handrail on the step side allows easy access to the maintenance port on the upper arm.

Maintenance work, daily checks, etc., can be done from ground level

The layout allows for easy access from the ground for many daily checks and regular maintenance tasks.



Engine oil filter



Fuel filter with built-in water-separator



iNDR filter/radiator reservoir tank/air cleaner



Control valve

Fast maintenance requires only a few procedures



Washer fluid tank is located under the cab floor mat.



Engine oil quick-drain valve can be turned without special tool.



Fuel tank features bottom flange and large drain valve.

Quality That Keeps on Shining. Valuable Assets Take Your Business to the Next Level.

Structural strength and proven reliability mean these machines can deal with heavy work loads and perform in rigorous site environments. From the lifecycle viewpoint, these machines maintain their value throughout their service lives.



Improved Filtration System Reliability

Clean, contaminant-free fuel and hydraulic fluid are essential to stable performance. The improved filtration systems reduce the risk of mechanical trouble and enhance longevity and durability.

Hydraulic fluid filter **NEW**

Recognized as the best in the industry, our premium-fine filter separates out even the smallest particles. New cover prevents contamination when changing filters.



Hydraulic fluid filter clog detector **NEW**

Pressure sensors at the inlet and outlet of the hydraulic fluid filter monitor differences in pressure to determine the degree of clogging. If the difference in pressure exceeds a predetermined level, a warning appears on the multi-display, so any contamination can be removed from the filter before it reaches the hydraulic fluid reservoir.

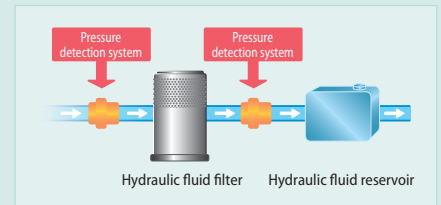

Enlarged fuel filter **NEW**

The enlarged fuel filter with built-in water separator maximizes filtering performance.

Easy cleaning saves time



Detachable two-piece floor mat has handles for easy removal. The mat's raised edges trap dirt and grit for easy cleaning.



Special crawler frame design makes it easy to clean off mud.

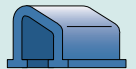

Double-element air cleaner

The large-capacity element features a double-filter structure that keeps the engine running clean even in industrial environments.

Long-life hydraulic oil:
5,000
hours

Long-interval maintenance

Long-life hydraulic oil reduces cost and labor.

Replacement cycle:
1,000
hours

Highly durable super-fine filter

The high-capacity hydraulic oil filter incorporates glass fiber with superior cleaning power and durability.

KOMEXS

KOBELCO MONITORING EXCAVATOR SYSTEM



Remote monitoring for peace of mind

KOMEXS (Kobelco Monitoring Excavator System) uses satellite communication and internet to relay data, and therefore can be deployed in areas where other forms of communication are difficult. When a hydraulic excavator is fitted with this system, data on the machine's operation, such as operating hours, location, fuel consumption, and maintenance status can be obtained remotely.

Direct Access to Operational Status

Location data

Accurate location data can be obtained even from sites where communications are difficult.

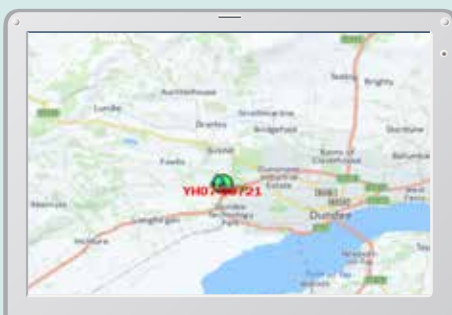

Latest location

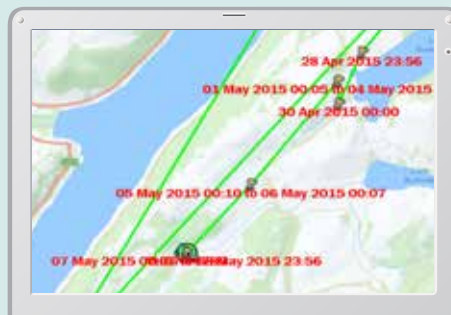

Location records

Type of Operation	Working Hrs	Ratio
Total Working Hrs	169 Hrs	100 %
Digging Hrs	72.2 Hrs	43 %
Traveling Hrs	18.3 Hrs	11 %
Idle Hrs	15.9 Hrs	9 %
Opt AM Hrs	62.5 Hrs	37 %
Crane Mode Hrs	0 Hrs	0 %

Work data

Operating hours

- A comparison of operating times of machines at multiple locations shows which locations are busier and more profitable.
- Operating hours on site can be accurately recorded, for running time calculations needed for rental machines, etc.

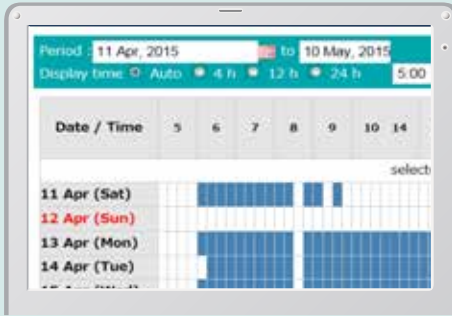

Daily report

Fuel consumption data

Data on fuel consumption and idling times can be used to indicate improvements in fuel consumption.

Work mode	Working Hrs	Total Fuel Consumption
H mode	2:06	24.5 L
S mode	0:00	0.0 L
E mode	169:19	1489.7 L
TOTAL	171:25	1514.2 L

Fuel consumption

Graph of work content

The graph shows how working hours are divided among different operating categories, including digging, idling, traveling and optional operations.

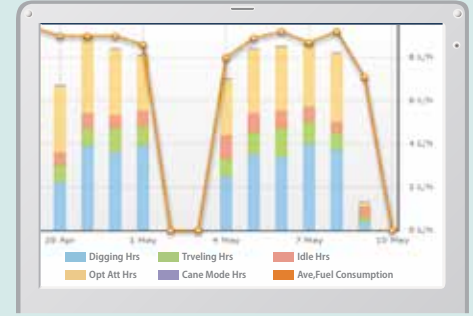

Work status

Maintenance Data and Warning Alerts

Machine maintenance data

- Provides maintenance status of separate machines operating at multiple sites.
- Maintenance data is also relayed to KOBELCO service personnel, for more efficient planning of periodic servicing.

Model	Serial No.	Hour Meter	Engine Oil
SK135RCLC-3/SK1405RCL	YH07-09221	734 Hr	434
SK135RCLC-3/SK1405RCL	YH07-09289	73 Hr	429
SK210LC-9	YQ13-10454	960 Hr	58
SK210LC-9	YQ13-10481	549 Hr	498
SK75SR-	YT08-20374		

Maintenance

Warning alerts

This system warns an alert if an anomaly is sensed, preventing damage that could result in machine downtime.

Alarm information can be received through E-mail

Alarm information or maintenance notice can be received through E-mail, using a computer or cell phone.



Messages displayed when the machine returns to the set area.

Daily/Monthly reports

Operational data downloaded onto a computer helps in formulating daily and monthly reports.

Security system

Engine start alarm

The system can be set an alarm if the machine is operated outside designated time.

Engine start alarm outside prescribed work time

Area alarm

It can be set an alarm if the machine is moved out of its designated area to another location.

Alarm for outside of reset area

Engine

Model	HINO J05EVA-KSDS
Type	Direct injection, water cooled, 4-cycle, 4-cylinder diesel engine with intercooler turbo-charger (Stage V-compliant engine)
No. of cylinders	4
Bore and stroke	112 mm x 130 mm
Displacement	5.123 L
Rated power output	119kW/2,000 min ⁻¹ (ISO 9249)
	124kW/2,000 min ⁻¹ (ISO 14396)
Max. torque	640N·m/1,600 min ⁻¹ (ISO 9249)
	660N·m/1,600 min ⁻¹ (ISO 14396)

Hydraulic System

Pump	
Type	Two variable displacement piston pumps + one gear pump
Max. discharge flow	2 x 220L/min 1 x 20L/min
Relief valve setting	
Boom, arm and bucket	34.3 MPa {350 kgf/cm ² }
Power Boost	37.8 MPa {385 kgf/cm ² }
Travel circuit	34.3 MPa {350 kgf/cm ² }
Swing circuit	29.0 MPa {296 kgf/cm ² }
Control circuit	5.0 MPa {50 kgf/cm ² }
Pilot control pump	Gear type
Main control valves	8-spool
Oil cooler	Air cooled type

Swing System

Swing motor	Axial piston motor
Brake	Hydraulic; locking automatically when the swing control lever is in the neutral position
Parking brake	Oil disk brake, hydraulic operated automatically
Swing speed	12.6 min ⁻¹ {rpm}
Swing torque	71.5 kN·m
Tail swing radius	1,690mm
Min. front swing radius	2,370mm

Attachments

Backhoe bucket and arm combination

Use			Backhoe bucket			
			Normal digging			
Bucket capacity	ISO Heaped	m ³	0.51	0.7	0.8	0.93
	Struck	m ³	0.39	0.52	0.59	0.67
Opening width	With side cutters	mm	870	1,080	1,160	1,330
	Without side cutters	mm	770	980	1,060	1,230
No. of bucket teeth			3	5	5	5
Bucket weight		kg	520	630	650	710
Combinations	2.87 m standard arm		○	○	◎	△

◎ Standard ○ Recommended △ Loading only

Travel System

Travel motors	2 x axial piston, two-speed motors
Travel brakes	Hydraulic brake per motor
Parking brakes	Oil disk brake per motor
Travel shoes	49 each side
Travel speed	5.8 / 3.5 km/h
Drawbar pulling force	229 kN {23,300kgf} (ISO 7464)
Gradeability	70% {35°}

Cab & Control

Cab	
All-weather, sound-suppressed steel cab mounted on the silicon-sealed viscous mounts and equipped with a heavy, insulated floor mat.	
Control	
Two hand levers and two foot pedals for travel	
Two hand levers for excavating and swing	
Electric rotary-type engine throttle	
Noise levels	
External	97dB(A) (ISO6395)
Operator	70dB(A) (ISO6396)

Boom, Arm & Bucket

Boom cylinders	120 mm x 1,355 mm
Arm cylinder	130 mm x 1,406 mm
Bucket cylinder	110 mm x 1,064 mm

Refilling Capacities & Lubrications

Fuel tank	330 L
Cooling system	24 L
Engine oil	20.5 L
Travel reduction gear	2 x 5.0 L
Swing reduction gear	2.7 L
Hydraulic oil tank	114 L tank oil level
	230 L hydraulic system
DEF/Urea tank	33.9 L

Working Ranges

Unit: m

Boom	5.62m
Arm	2.87m
Range	2.87m
a- Max. digging reach	9.70
b- Max. digging reach at ground level	9.53
c- Max. digging depth	6.58
d- Max. digging height	10.58
e- Max. dumping clearance	7.71
f- Min. dumping clearance	2.98
g- Max. vertical wall digging depth	5.95
h- Min. swing radius	2.37
i- Horizontal digging stroke at ground level	5.03
j- Digging depth for 2.4 m (8') flat bottom	6.37
Bucket capacity ISO heaped m ³	0.80

Digging Force (ISO 6015)

Unit: kN

Arm length	2.87m
Bucket digging force	120 132*
Arm crowding force	88 96.8*

*Power Boost engaged.

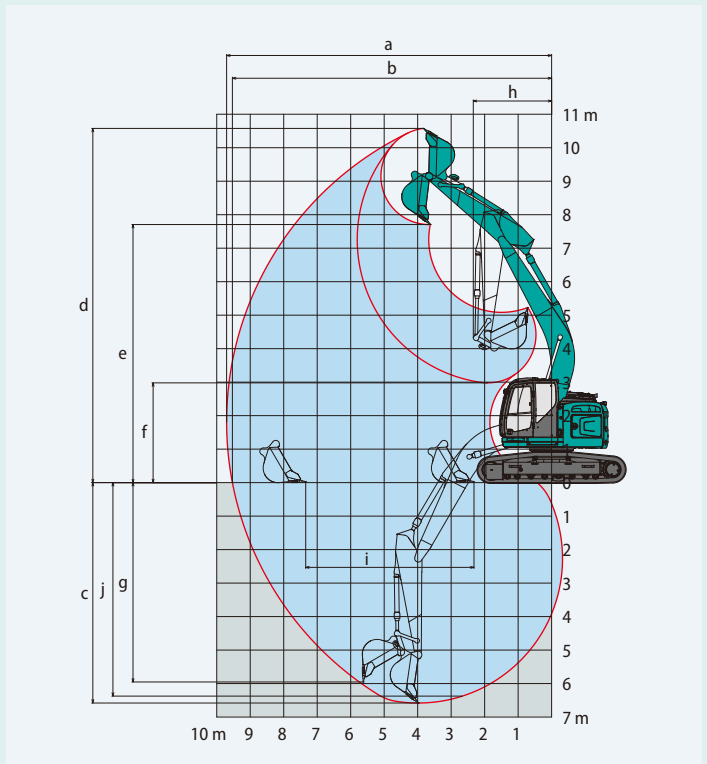

Dimensions

Arm length	2.87m
A Overall length	8,830
B Overall height (to top of boom)	3,160
C Overall width	2,990
D Overall height (to top of cab)	3,160
E Ground clearance of rear end*	1,030
F Ground clearance*	445
G Tail swing radius	1,690

Unit: mm

G'	Distance from center of swing to rear end	1,680
H	Tumbler distance	3,660
I	Overall length of crawler	4,450
J	Track gauge	2,390
K	Shoe width	600
L	Overall width of upperstructure	2,990

*Without including height of shoe lug.

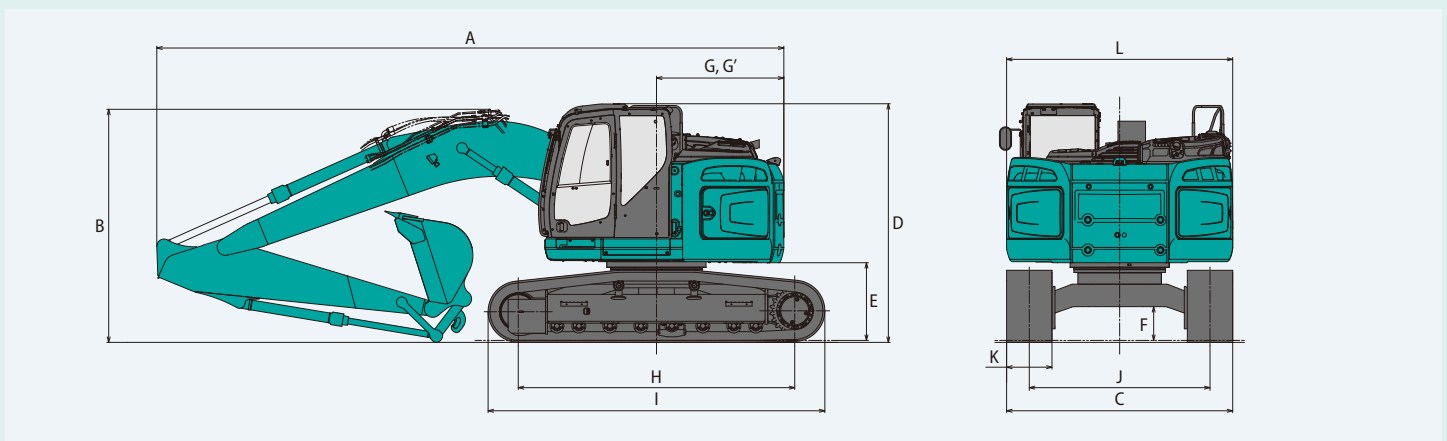

Operating Weight & Ground Pressure

In standard trim, with standard boom, 2.87 m arm, and 0.8 m³ ISO heaped bucket

Shaped	Triple grouser shoes (even height)				
Shoe width	mm	600	700	790	900
Overall width	mm	2,990	3,090	3,180	3,290
Ground pressure	kPa	49	43	38	34
Operating weight	kg	23,800	24,100	24,300	24,600
Ground pressure with dozer	kPa	53	-	-	-
Operating weight with dozer	kg	25,400	-	-	-

Lifting Capacities

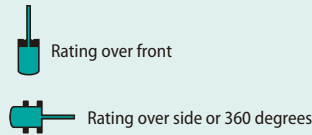
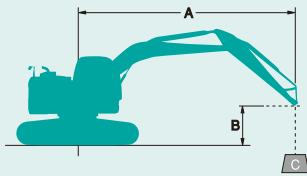

A: Reach from swing centerline to arm top
 B: Arm top height above/below ground
 C: Lifting capacities in Kilograms
 Bucket: Without bucket
 Relief valve setting: 37.8 Mpa {385 kgf/cm²}

Mono Boom Specifications

SK230RSLC		Arm: 2.87 m		Bucket: without		Counterweight: 5,910 kg		Shoe: 600 mm		HEAVY LIFT				
B	A	1.5 m		3.0 m		4.5 m		6.0 m		7.5 m		At Max. Reach		Radius
		Rating over front	Rating over side or 360 degrees	Rating over front	Rating over side or 360 degrees	Rating over front	Rating over side or 360 degrees	Rating over front	Rating over side or 360 degrees	Rating over front	Rating over side or 360 degrees	Rating over front	Rating over side or 360 degrees	
9.0 m	kg											*3,930	*3,930	3.99 m
7.5 m	kg					*5,320	*5,320					*3,220	*3,220	5.97 m
6.0 m	kg					*5,810	*5,810	*5,350	5,010			*2,990	*2,990	7.11 m
4.5 m	kg			*9,260	*9,260	*7,790	7,600	*6,590	4,850	*4,270	3,390	*2,950	*2,950	7.81 m
3.0 m	kg					*9,430	7,040	*7,300	4,610	5,220	3,290	*3,040	2,870	8.18 m
1.5 m	kg					*10,770	6,540	7,130	4,370	5,100	3,180	*3,260	2,760	8.25 m
G.L.	kg			*6,430	*6,430	10,980	6,270	6,940	4,200	5,010	3,100	*3,670	2,810	8.05 m
-1.5 m	kg	*6,680	*6,680	*10,560	*10,560	*10,660	6,200	6,870	4,140	*4,960	3,080	*4,420	3,060	7.55 m
-3.0 m	kg	*10,930	*10,930	*12,280	12,190	*9,200	6,270	*6,820	4,180			*5,740	3,650	6.67 m
-4.5 m	kg			*8,190	*8,190	*6,230	*6,230					*5,000	*5,000	5.24 m

SK230RSLC		Arm: 2.87 m		Bucket: without		Counterweight: 5,910 kg + 1,400 kg		Shoe: 600 mm		HEAVY LIFT				
B	A	1.5 m		3.0 m		4.5 m		6.0 m		7.0 m		At Max. Reach		Radius
		Rating over front	Rating over side or 360 degrees	Rating over front	Rating over side or 360 degrees	Rating over front	Rating over side or 360 degrees	Rating over front	Rating over side or 360 degrees	Rating over front	Rating over side or 360 degrees	Rating over front	Rating over side or 360 degrees	
9.0 m	kg											*3,930	*3,930	3.99 m
7.5 m	kg					*5,320	*5,320					*3,220	*3,220	5.97 m
6.0 m	kg					*5,810	*5,810	*5,350	*5,350			*2,990	*2,990	7.11 m
4.5 m	kg			*9,260	*9,260	*7,790	*7,790	*6,590	5,510	*4,270	3,890	*2,950	*2,950	7.81 m
3.0 m	kg					*9,430	8,010	*7,300	5,270	*5,860	3,800	*3,040	*3,040	8.18 m
1.5 m	kg					*10,770	7,510	*7,960	5,030	5,750	3,680	*3,260	3,210	8.25 m
G.L.	kg			*6,430	*6,430	*11,190	7,240	7,830	4,860	5,660	3,600	*3,670	3,270	8.05 m
-1.5 m	kg	*6,680	*6,680	*10,560	*10,560	*10,660	7,170	7,760	4,800	*4,960	3,580	*4,420	3,550	7.55 m
-3.0 m	kg	*10,930	*10,930	*12,280	*12,280	*9,200	7,240	*6,820	4,840			*5,740	4,230	6.67 m
-4.5 m	kg			*8,190	*8,190	*6,230	*6,230					*5,000	*5,000	5.24 m

- Do not attempt to lift or hold any load that is greater than these lift capacities at their specified lift point radius and heights. Weight of all accessories must be deducted from the above lift capacities.
- Lift capacities are based on machine standing on level, firm, and uniform ground. User must make allowance for job conditions such as soft or uneven ground, out of level conditions, side loads, sudden stopping of loads, hazardous conditions, experience of personnel, etc.
- Arm top defined as lift point.
- The above lifting capacities are in compliance with ISO 10567. They do not exceed 87% of hydraulic lifting capacity or 75% of tipping load. Lifting capacities marked with an asterisk (*) are limited by hydraulic capacity rather than tipping load.
- Operator should be fully acquainted with the Operator's and Maintenance Instructions before operating this machine. Rules for safe operation of equipment should be adhered to at all times.
- Lift capacities apply to only machine as originally manufactured and normally equipped by KOBELCO CONSTRUCTION MACHINERY CO., LTD.

STANDARD EQUIPMENT**ENGINE**

- Engine, HINO J05EVA-KSDS engine with turbocharger and intercooler, Stage V certified
- Automatic engine deceleration
- Auto idle Stop (AIS)
- Batteries (2 x12V - 96 Ah)
- Starting motor (24 V - 5kW), 60 A alternator
- Automatic engine shut-down for low engine oil pressure
- Engine oil pan drain valve
- Double element air cleaner
- Refueling pump

CONTROL

- Working mode selector (H-mode, S-mode and ECO-mode)
- Power Boost
- Gear pump
- Extra N&B piping (proportional hand controlled)
- Object Handling Kit (boom safety + hook)
- Quick Coupler piping

SWING SYSTEM & TRAVEL SYSTEM

- Swing rebound prevention system
- Straight propel system
- Two-speed travel with automatic shift down
- Sealed & lubricated track links
- Grease-type track adjusters
- Automatic swing brake

MIRRORS, LIGHTS & CAMERAS

- Rear view mirrors, rearview camera and side view camera
- Three front working lights

CAB & CONTROL

- Two control levers, pilot-operated
- Horn, electric
- Integrated left-right slide-type control box
- Cab light (interior)
- Coat hook
- Large cup holder
- Detachable two-piece floor mat
- Air suspension seat with heater
- Seatbelt
- Headrest
- Handrails
- Heater and Defroster
- Intermittent windshield wiper with double-spray washer
- Sky light
- Top guard (ISO 10262 : 1998)
- Tinted safety glass
- Pull-type front window and removable lower front window
- Easy-to-read multi-display monitor
- Automatic air conditioner
- Emergency escape hammer
- EU radio (AUX & USB & Bluetooth)
- Pressure release switch
- DPF switch
- 12V converter
- Hydraulic fluid filter clog detector
- Remote machine monitoring system "KOMEXS"
- Tow eyes

OPTIONAL EQUIPMENT

- Wide range of shoes
- Front-guard protective structure (may interfere with bucket action)
- Add-on counterweight (+ 1400 kg)
- Cab additional light
- 7-way adjustable suspension seat
- Bigger capacity P4 pump and steel PTO housing
- Rain visor (may interfere with bucket action)
- Lower under cover
- Additional track guide
- Dozer blade (only for 600 mm shoe)
- Travel alarm

Note: Standard and optional equipment may vary. Consult your KOBELCO dealer for specifics.

Note: This catalog may contain attachments and optional equipment that are not available in your area. And it may contain photographs of machines with specifications that differ from those of machines sold in your areas. Please consult your nearest KOBELCO distributor for those items you require. Due to our policy of continuous product improvements all designs and specifications are subject to change without advance notice.

Copyright by **KOBELCO CONSTRUCTION MACHINERY CO., LTD.** No part of this catalog may be reproduced in any manner without notice.

KOBELCO CONSTRUCTION MACHINERY EUROPE B.V.

Veluwezoom 15
1327 AE Almere
The Netherlands
www.kobelco-europe.com

Enquiries To: